

ICON FIRES

Slimline Burner Manual

www.iconfires.com

Operating Manual

Thank you for purchasing this Icon Fires product. Icon Fires places the highest priority on safety of its products. Every care has been taken in designing, manufacturing and assembling your Icon Fires Burner to ensure it operates effectively, efficiently and safely. Live-fire products must be treated with care. We ask that you exercise care when using this product and follow the instructions below. Before using your Icon Fires Burner, please read all the information contained in this Operation Manual carefully. Icon Fires cannot be held responsible for any damage or injury caused if these instructions are not followed.

Retain this Manual for future reference.

IMPORTANT SAFEGUARDS

When using this Fireplace, basic precautions should always be followed, including but not limited to the following. **Read all instructions and warnings before using this Fireplace.**

WARNING

- **DO NOT OVERFILL THE BURNER'S INTENDED CAPACITY.**
- **NEVER LEAVE THE APPLIANCE UNATTENDED DURING OPERATION OR WHEN A FLAME IS PRESENT.**
- **DO NOT IGNITE THE COMBUSTION CHAMBER WHEN IT IS IN A HOT STATE.**
- **USE ONLY THE FUEL FOR WHICH THE SLIMLINE BURNER IS INTENDED.**
- **DO NOT TOUCH THE EXTERIOR OF THE SLIMLINE BURNER DURING OR AFTER BURNING.**
- **PARTS OF THIS SLIMLINE BURNER CAN REACH HIGH TEMPERATURES.**
- **DO NOT HAVE COMBUSTIBLE OBJECTS IN CLOSE PROXIMITY TO THE BURNER.**
- **UNLESS THE BURNER IS OUTDOORS, DO NOT INSTALL INTO AN AREA WHERE THERE IS A DRAFT WHICH CAN AFFECT THE FLAME.
ESPECIALLY WHEN INSTALLING IN OLD HEARTH, MAKE SURE HEARTH IS SEALED.**
- **NEVER POSITION THE BURNER WITHIN RANGE OF COMBUSTIBLE ITEMS THAT CAN BE MOVED/BUMPED BY ACCIDENT OR BLOWN BY THE WIND. E.G. CURTAINS, BLANKETS, PAPERS ETC...**
- **ONLY USE THE SLIMLINE BURNER IN AREAS WITH GOOD VENTILATION.**
- **DO NOT COVER THE SLIMLINE BURNER VENT WITH ANY DECORATIVE ITEMS WHETHER THEY ARE COMBUSTIBLE OR NON-COMBUSTIBLE, INCLUDING BUT NOT LIMITED TO ARTIFICIAL LOGS, STONES, PEBBLES, GLASS BEADS etc.**
- **CUSTOMS INSTALLATION: ICON FIRES IS NOT LIABLE FOR ANY INJURIES OR DAMAGES SUSTAINED BY CUSTOM MADE OR PRIVATELY COMMISSIONED FIREBOXES. ICON FIRES RECOMMENDS USING THE BURNERS IN THE FIREBOXES MANUFACTURED BY ICON FIRES ONLY. ANY ALTERATIONS TO THE ICON PRODUCT VOIDS ANY WARRANTY OR LIABILITY.**
- **WARNING: FILLING AND ALCOHOL FUELLED DEVICE WHILE LIT HAS CAUSED SEVERE BURNS AND DEATHS. WHEN REFILLING FIRST CHECK THE FLAME IS EXTINGUISHED AND THAT THE DEVICE IS COOL.**

CAUTION

- **Make sure you have read and understood this manual before using this product.**
- **Do not overfill or spill fuel when refilling.**
- **If fuel is spilled onto the surface of the Firebox WIPE IT IMMEDIATELY AND LEAVE TO DRY BEFORE LIGHTING THE BURNER.**
- **If fuel is spilled on the stainless steel Burner during filling, wipe with a dry cloth and allow the rest to evaporate before lighting the Burner.**
- **If the Burner is accidentally overfilled, follow the steps in the Burner manual to rectify.**
- **To refill, wait until the Burner is at the room temperature after the flame has been turned off.
NOTE: the flame may not be visible to the naked eye in daylight and must be cool before filling.**
- **NEVER refill over or near an open flame and use a decanter with a flame arrestor only.**
- **Remove all plastic & packaging before using the Burner.**

Trouble shooting and operating tips:

- The hooks on the back of the **Sliding Lid Handle** can be used to carry the *Slimline Burner* by hooking it around the slotted openings in the *Vent Plate* as shown in the image below. Not Applicable to Round Burner.
- The **first fill** will take longer and more fuel as the material inside the *Fuel Tank* will absorb the fuel. Subsequent filling should be quicker with less fuel. Take care to not fill the burner at a faster rate than what the material inside can absorb.
- If the fire **does not extinguish** the first time by closing the *Sliding Lid* follow these steps and repeat if necessary.
 - Check that the surface below the sliding plate is clean and free from obstruction.
 - Apply strong downward force and in one quick motion move the sliding plate towards the closed position. If the flame is still visible repeat this step as a double motion still applying strong downward force in quick succession.
- **Never blow on the flame** whilst the *Sliding Lid* is in an open position.
- We recommend to refill your Burner to its intended capacity before every use.
- **VERY IMPORTANT: Take special care when adding fuel to the Slimline Burner, always close the Sliding Lid for a few minutes before adding fuel to make sure there is no visible flame in the Burner Vent.**
- If after some time you find the *Sliding Lid* has **become 'sticky'** when attempting to move it then remove the *Sliding Lid* from its housing and rub the underside using the green side of a Scotch Bright scouring pad. Take care to only scrub in the direction of the brushing lines of the stainless steel. Not applicable to Round Burner.
- Make sure you keep your Burner clean especially the surface that the *Sliding Lid* slides on and ensure that any excess fuel on the surface of the Burner is wiped off before use.
- In Australia it is mandatory for all products to be supplied with a Fuel Canister which has a flame arrestor. Cocoon Fires supplies a fuel canister with a flame arrestor in the Australian market. We recommend in all markets to use a fuel canister with a flame arrestor.

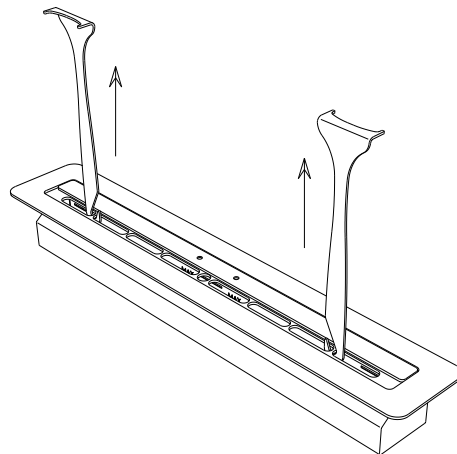

CONTENT OF PACKAGING:

- Burner Body - qty 1
- Slider or Closing lid for Round Burner - qty 1 (2 of for 1400 Burner)
- Sliding Lid Handle - qty 2 (1 of for 500 and Round Burner)
- Battery operated Fuel Pump* - qty 1 (None for Round Burner)
- Flame reducer rings for round burner - qty 1 x large reducer, 1 x small reducer

* Australian models are not supplied with a Fuel Pump. They are supplied with the mandatory fuel canister with flame arrestor.

MAKE SURE THE FIREPLACE HAS COOLED OFF COMPLETELY BEFORE CLEANING:

To clean dust, wipe with a dry cloth or sponge.

To clean stainless steel parts, use bioethanol or Acetone.

Make sure the Sliding Lid for the Slimline Burner slides correctly and fully after cleaning and that any excess cleaning product has been wiped off completely.

KEEP HANDY A CLASS ABE FIRE EXTINGUISHER:

Class ABE fire extinguishers are used to put out fires that are caused by combustible liquids. Class ABE fire extinguishers quell the flames by expelling a dry chemical powder or foam with a nitrogen propellant. The specific chemical can vary depending on the make or model. Water will not extinguish this flame.

PROCEDURE IF BURNER IS OVERFILLED:

In case of accidental overfilling of the fuel tank, follow these steps:

- NEVER light the Slimline Burner if it is filled past the **filling line by more than 5mm**, shown in the section of **Filling the Slimline Burner**.
- Remove the Slimline Burner from its housing, using the hooks on the back end of the *Sliding Lid Handle* or rubber gloves.
- Empty excess fuel into a container suitable to hold the volume of the Burner, kitchen sink or toilet bowl.
- Wipe off all excess fuel that may have dripped on the outside of the Slimline Burner during emptying and allow any residual fuel to evaporate. Leave for 1 hour.
- Place the Slimline Burner back into its housing.
- Ignite the Slimline Burner only once all residual fuel outside the Burner has completely evaporated and the dispenser used to fill the Burner has been sealed and moved to a safe distance from the Burner.

USE CORRECT FUEL: BIOETHANOL



ICON  FIRES

Slimline Burner Range

The following information is provided to assist in understanding how each model within our collection can be incorporated into your desired settings. It is intended as a guide only and it is important that you read the detailed *Model Specification* of the model you are interested in before ordering, specifying, installing or operating the fire.

Model No.	Dimensions in mm (L x W x H)	Approx. Fuel Capacity	Material	Heats On Average	Minimum Room Area	Thermal Output Net	Burning Time On *Average	Consumption *Average
SB500	500x100x100	2.75 ℓ	Brushed 304 SS	up to 90 m ³	40 m ³	2.5 kW/hr	6-9 hrs	0.30 ℓ/hr
SB800	800x100x100	4.50 ℓ	Brushed 304 SS	up to 165 m ³	70 m ³	5.0 kW/hr	5.5-8.5 hrs	0.60 ℓ/hr
SB1100	1100x125x100	6.25 ℓ	Brushed 304 SS	up to 210 m ³	90 m ³	7.25 kW/hr	6.5-9 hrs	0.90 ℓ/hr
SB1400	1400x125x100	8.15 ℓ	Brushed 304 SS	up to 270 m ³	110 m ³	9.5 kW/hr	7-9.5 hrs	0.90 ℓ/hr
RD380	380x380x100	6 ℓ	Brushed 304 SS	up to 290 m ³	130 m ³	10.5 kW/hr	6-12 hrs	0.65 ℓ/hr

*Average consumption and burn time are based on mixed settings of maximum and moderate output. These burn times and consumption rates may vary depending on room characteristics.

Accompanying Accessories

Model No.	Burner & Lid	Fuel Pump*	Handles	Instruction Manual
SB500	yes	yes	1	yes
SB800	yes	yes	2	yes
SB1100	yes	yes	2	yes
SB1400	yes	yes	2	yes
RD380	yes	no	1	yes

* Australian models are not supplied with a fuel pump . They are supplied with the mandatory fuel canister with flame arrestor.

ICON  FIRES

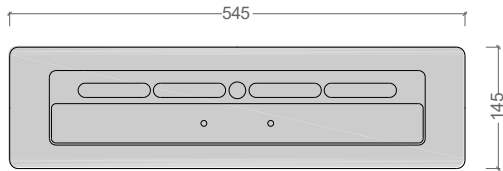

Top View - SB500

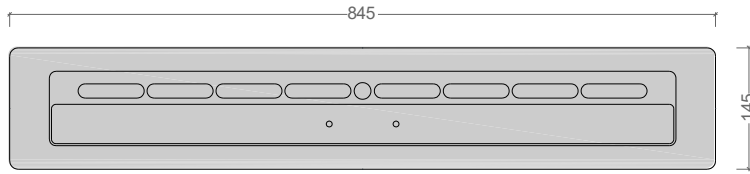

Top View - SB800

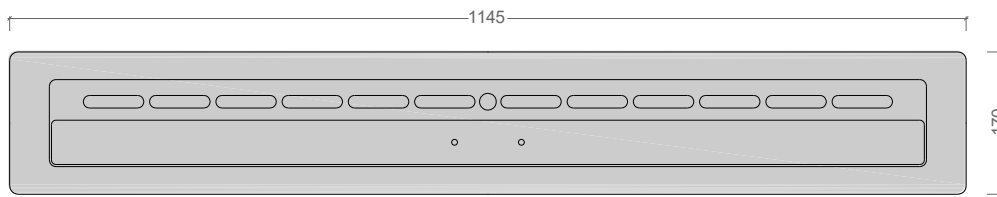

Top View - SB1100

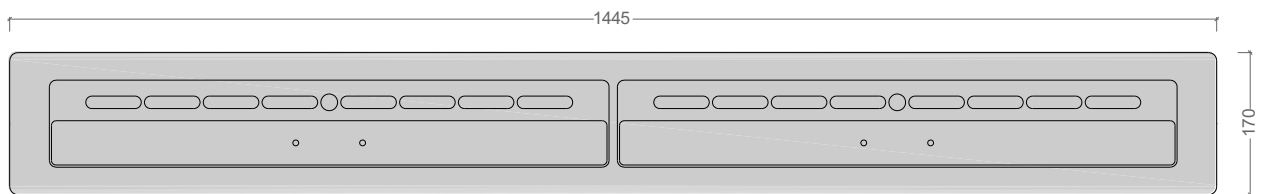

Top View - SB1400

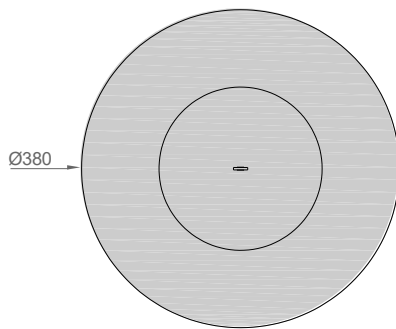

Top View - RD380

NOTE: There are many different variations available for installing the Burner Range. In all cases, the Slimline Burner must:

- Installed into non-combustible material ONLY;
- All gas connections or pipelines near your new Burner installation must be disconnected and made safe by an appropriately qualified professional prior to installation;
- Installed into a fixed, level and secure position before filling, lighting and operating;

- Installed in a position that limits relocation requirements to eliminate the risk of accidents caused by fuel spillage. These Burners are not designed to be relocated frequently;
- Installed into a level platform;
- Not installed directly beside or near wallpaper, laminate, veneer or any surface that has not been fire rated and considered combustible.
- A minimum of 1000mm radius to any combustible material.
- Not be within the reach of any objects that are not fixed in position and can be moved by the wind or bumped over easily i.e. curtains, blankets, newspapers etc.

Installation Clearances

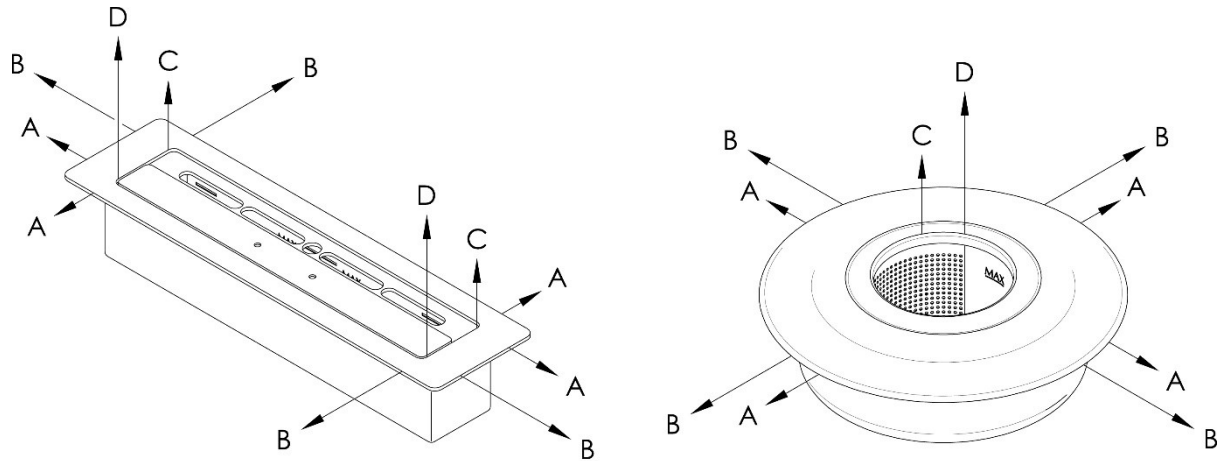

NOTE: all distances are measured from the top plate of the burner, these distances are very important to ensure safe and efficient usage

Burner Clearances

	TO COMBUSTIBLE MATERIALS				TO NON-COMBUSTIBLE MATERIALS			
	A	B	C	D	A	B	C	D
SB500	1000mm	1000mm	2000mm	2000mm	50mm	50mm	500mm	500mm
SB800	1000mm	1000mm	2000mm	2000mm	50mm	50mm	500mm	500mm
SB1100	1000mm	1000mm	2000mm	2000mm	50mm	50mm	500mm	500mm
SB1400	1000mm	1000mm	2000mm	2000mm	50mm	50mm	500mm	500mm
RD380	1000mm	1000mm	2000mm	2000mm	50mm	50mm	500mm	500mm

ICON  FIRES

1 - Filling the Slimline Burner

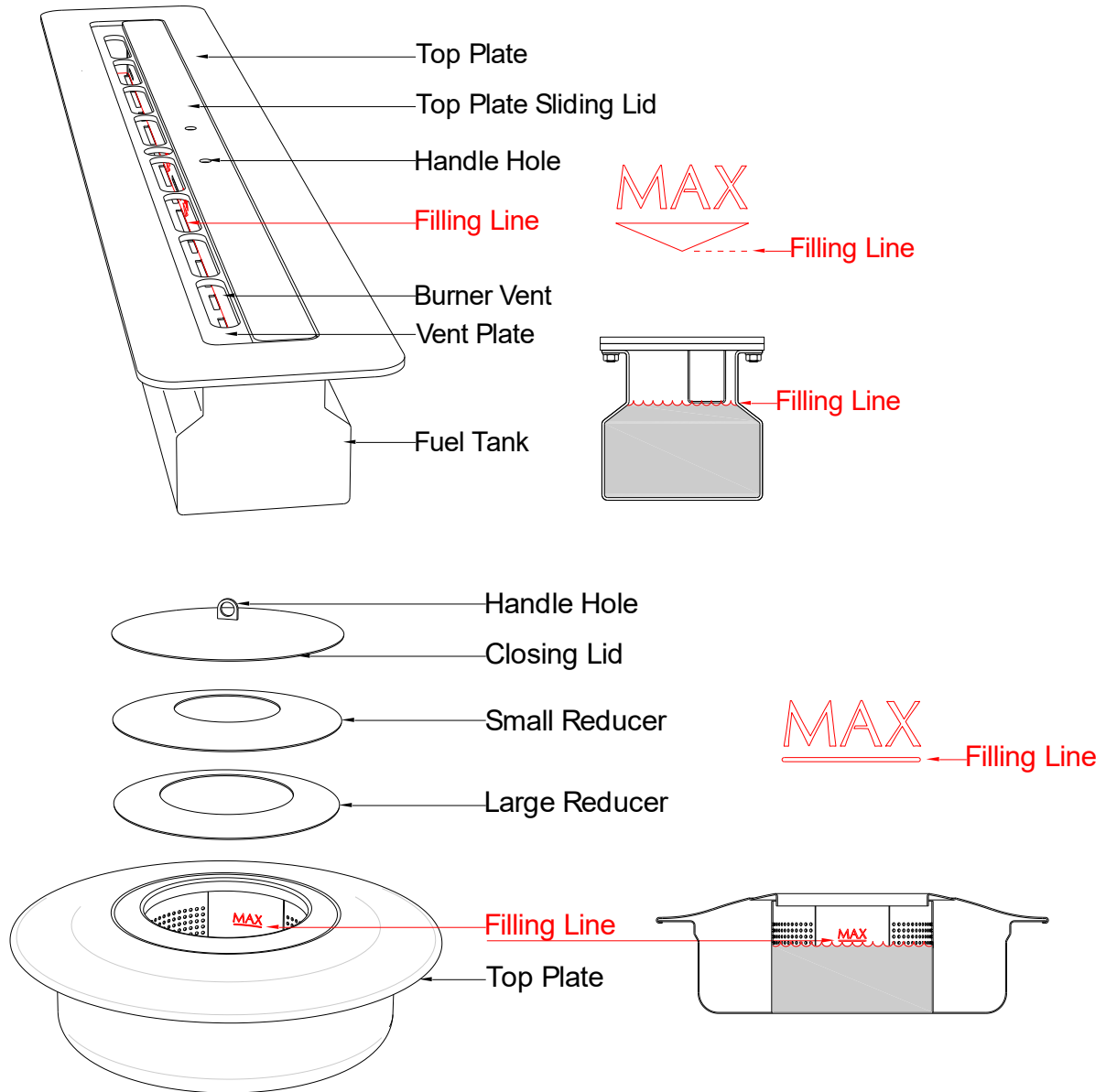

THE BURNER MUST BE COOL BEFORE REFILL!

Fill the Slimline Burner Fuel Tank to the Fill Line until the fuel becomes visible at the bottom of the Burner Vent. Fill using the Fuel Pump supplied (where applicable) or a funnel that fits in the centre hole of the Vent Plate. **DO NOT OVERFILL**

Please wipe any spillage or excess fuel before proceeding to Step 2.



**DO NOT FILL
WHILE OPERATING!**



**DO NOT FILL
WHEN HOT!**

2 - Igniting the Slimline Burner

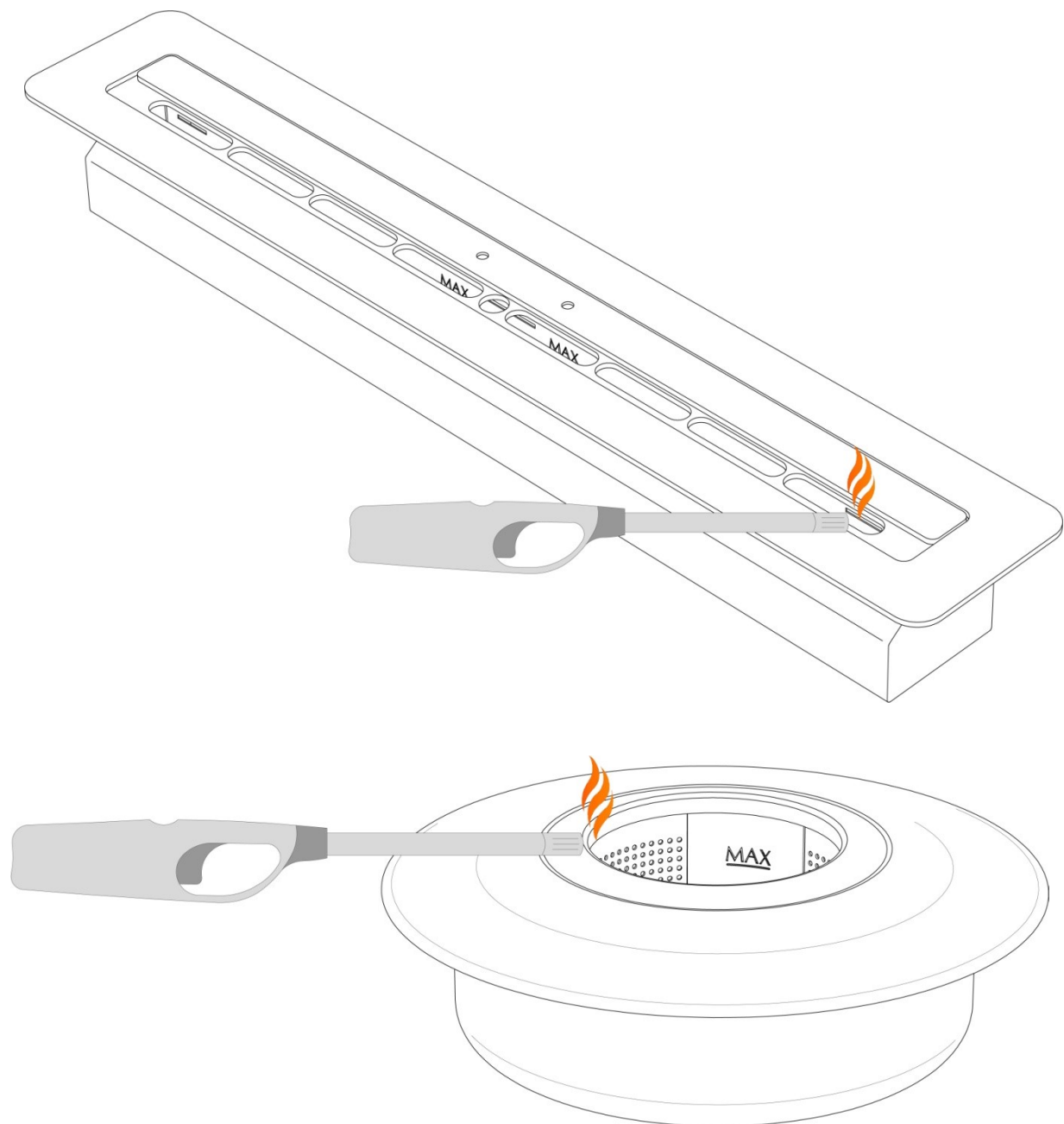

Seal the fuel canister used to fill the Burner and move to a safe distance away from the Burner. While standing at arm's length away from the Burner, use a long arm lighter as per the image above to introduce a flame to the openings in the *Vent Plate*. If the *Burner* has fuel in the reservoir but is not igniting, close the *Sliding Lid* for 5 minutes then open the *Sliding Lid*. Ensure there are no flames visible within the burner vent opening, then pour a small amount of fuel across the length of the *Burner Vent* with the supplied plastic bottle (where applicable) and introduce the flame. This normally happens when the burner has been closed for a day or more.

Note: If fuel is left in the burner for a prolonged time or overnight, before next use, open the *Vent* for 2 minutes and let it air before ignition, to let the fuel vapour clear, and only then light.

3 - Adjusting the Flame Size

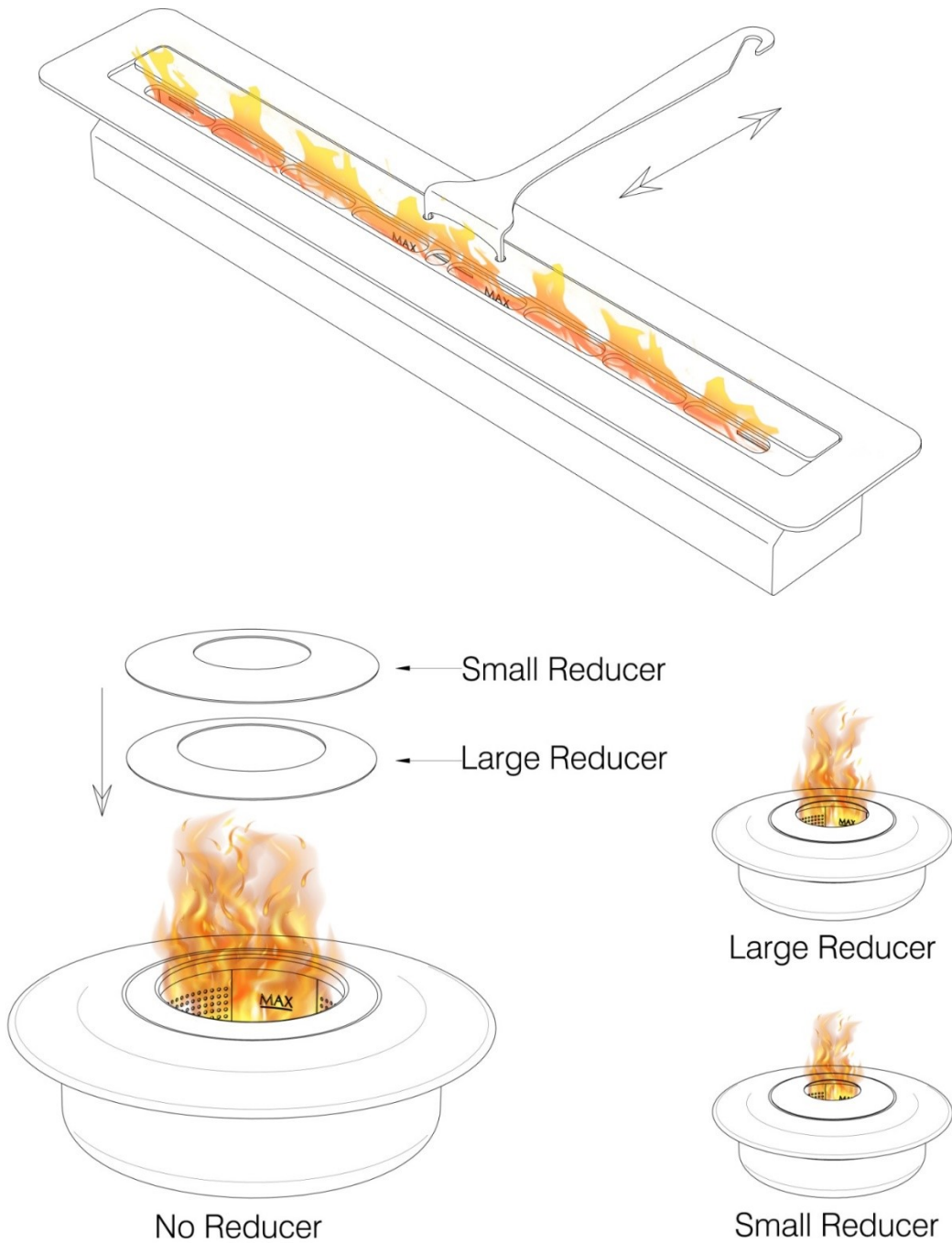

The flame intensity is adjusted by inserting the *Sliding Lid Handle's* tip into the corresponding holes in the *Top Plate Sliding Lid* as indicated above. Note the flame intensity takes a few minutes to change after an adjustment has been made. The Round Burner flame is adjusted by placing either the large or small reducer ring on top of the burner.

ICON  FIRES

4 - Extinguishing the Flame

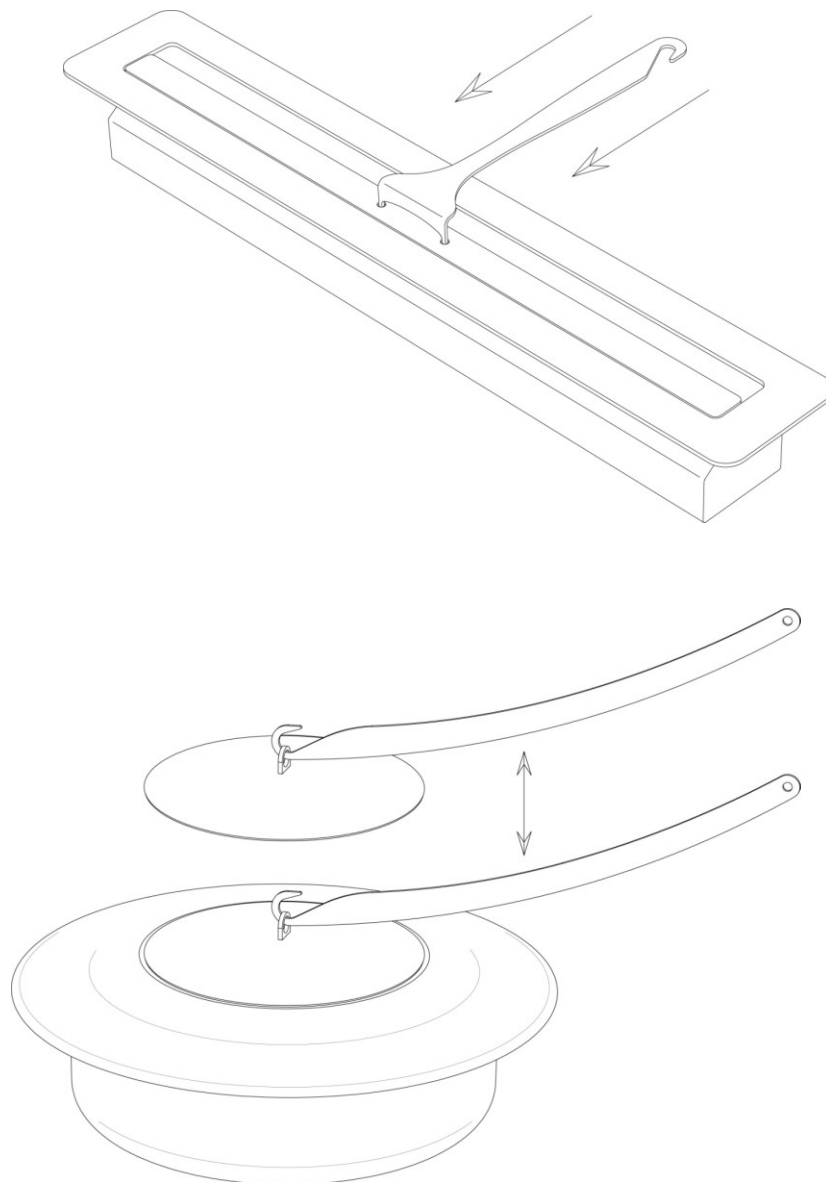

Using the *Sliding Lid Handle*, push the *Sliding Lid* to the front / closed position. Should the flame not extinguish with the first try please repeat until extinguished. It should be a swift action coupled with downward pressure.

For the Round Burner simply place the closing lid on top of the burner making sure it fits into its position.

Burner cut out dimensions

Round Burner – RD380

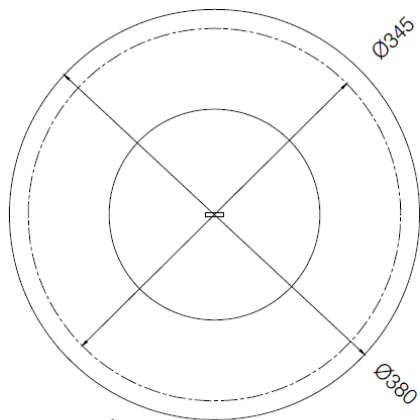

Top View

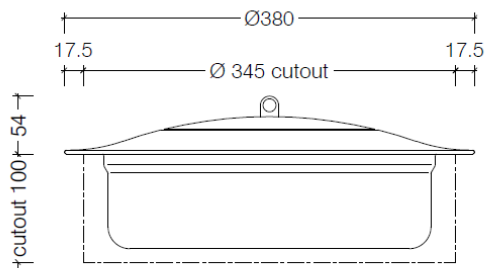

Front View

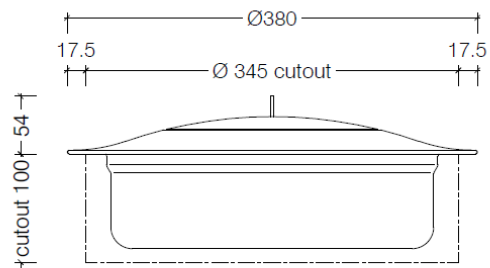

Side View

SB500

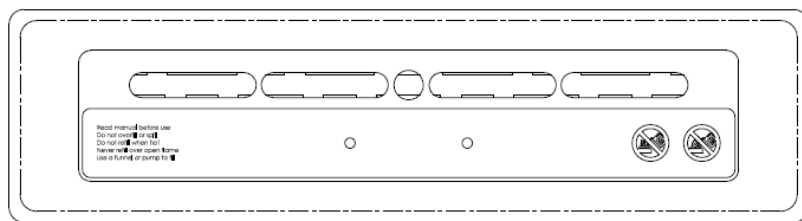
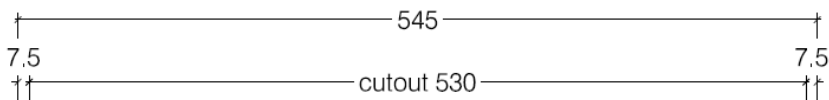

Top View

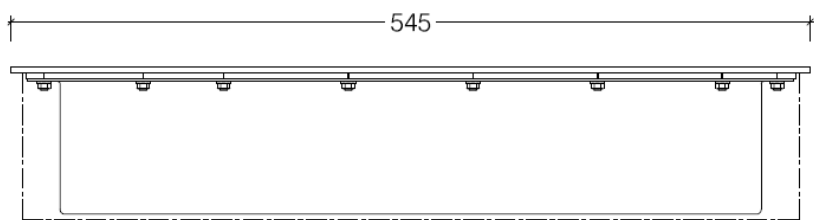
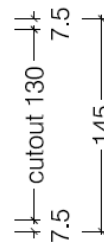

Front View

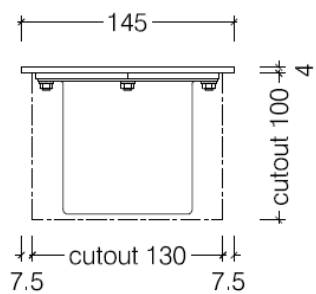

Side View

SB800

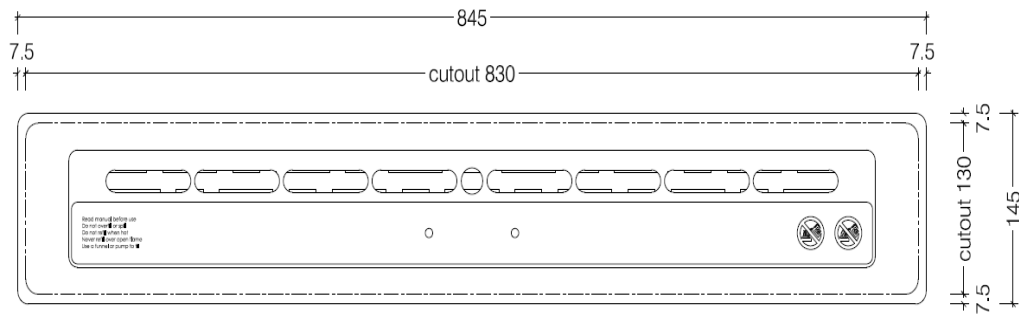

Top View

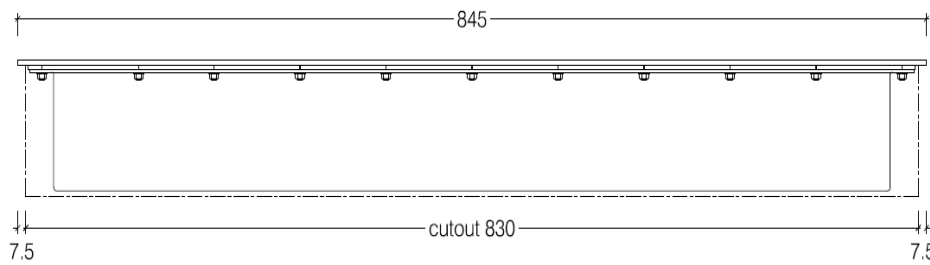

Front View

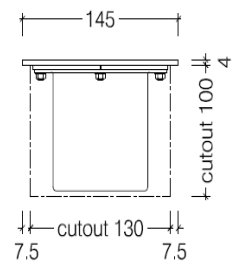

Side View

SB1100

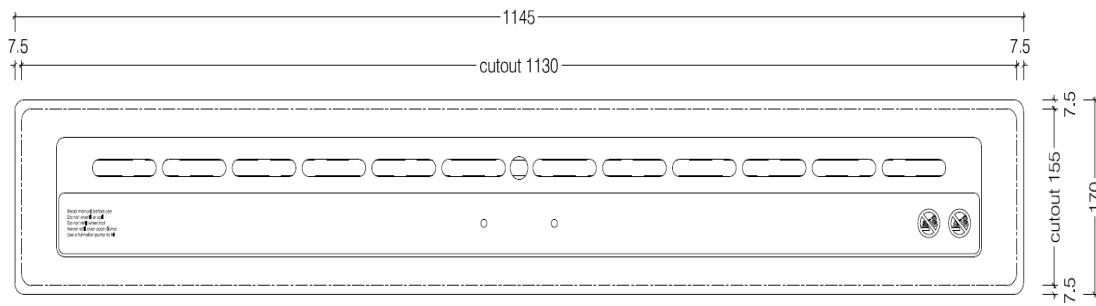

Top View

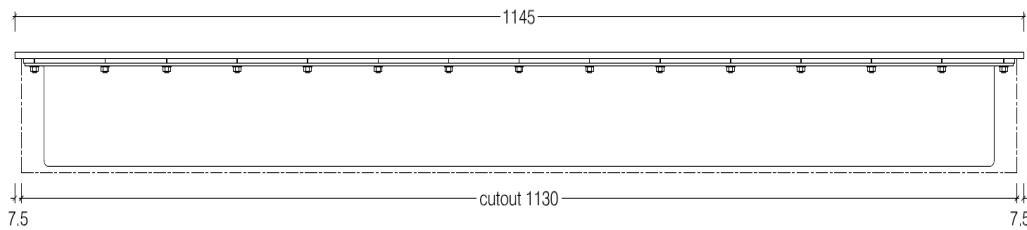

Front View

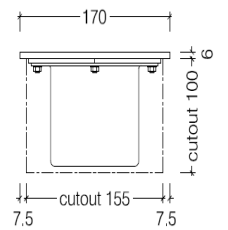

Side View

SB1400

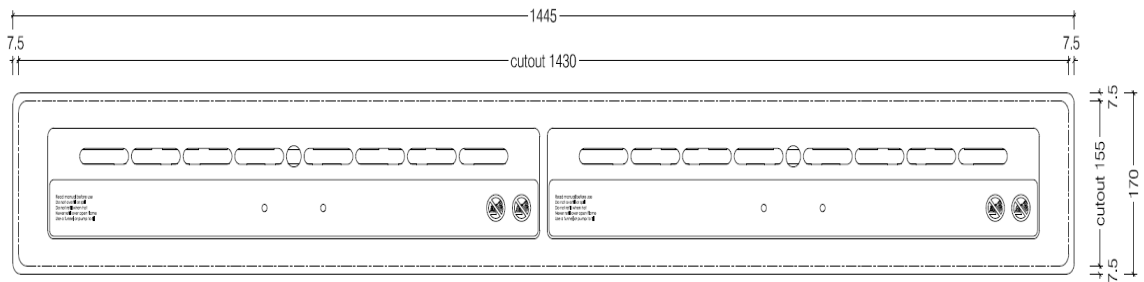

Top View

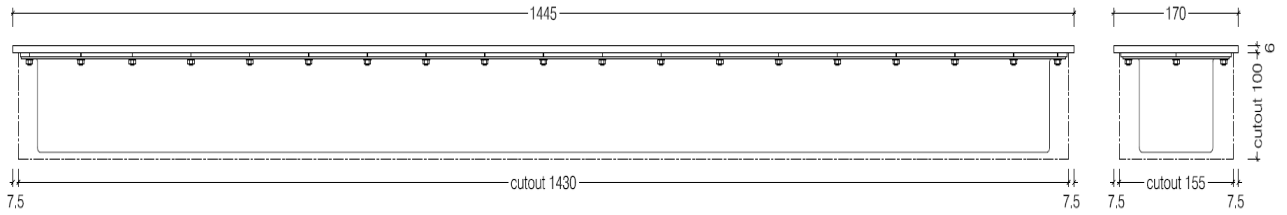

Front View

Side View

Icon Fires Warranty Terms and Conditions

1. All warranty claims are subject to manufacturer's review and acceptance.
2. Icon Fires warrants that it uses reasonable care and skill to ensure that its products are of reasonable quality. Icon Fires will at its cost and in its sole discretion: (i) remedy any defect or fault in any product purchased; or (ii) replace any product in respect of which there is a defect or fault, during the warranty period, provided that written notice is given by the Purchaser to Icon Fires of any such defect or fault in the product as soon as the Purchaser becomes aware of that fault or defect. All warranty claims must be returned to Icon Fires for assessment with a receipt or other proof of payment. No warranty is given in respect of any glass contained in any product.
3. Icon Fires has no liability to remedy any defect in a product or replace a product where the defect or fault is caused or contributed to by (i) the failure of the Purchaser to install the product according to specific installation instructions either supplied within each product box or carton or available on the Icon Fires website or through the retailer representative; or (ii) use of the product in a manner or for a purpose for which it was not designed.
4. All site application or installation must reflect these procedures otherwise the product warranty will be considered void or will not take effect.

All products bearing the logo of Icon Fires logo is covered by a 2-year warranty.

IMPORTANT:

- **Stone chipping, painting scratches and general scratches are not covered by the Warranty.**
- **Due to the characteristics of Stainless Steel, over time the finish will mature through natural processes associated with the use with heat and a flame.**
- **Is it recommended the Stainless Steel Components be polished annually with a non abrasive polish to bring & restore the finish and also to regularly clean the products from residue and dirt.**
- **The Warranty does not cover any oxidisation of material and/or the occurrence of patina.**



QC Checklist

Components

- Handles 2 of (500 Burner only 1 of).....
- Slider 1 of (1400 Burner 2 of).....
- Manual 1 of.....
- Burner body 1 of.....

Checked by.....

